



DKG-190

BATTERY CHARGE CONTROLLER

DESCRIPTION

The DKG-190 is a high-tech product designed to reduce engine run hours of gensets used in telecommunication systems.

The unit brings considerable economies to genset run-hours, fuel consumption and service cost.

In simple telecom systems, gensets run during mains failure periods. Thus the genset run hour is equal to the sum of mains failure hours.

The DKG-190 feeds the existing genset control unit with the AC voltage that it generates internally and prevents the engine from running when not necessary. It also controls the mains contactor. It can be adapted to any brand and model of genset control unit.

When the mains is off, the DKG-190 continues to feed the genset controller with AC voltage and monitors the battery voltage. When the battery voltage falls below the preprogrammed level, then it cuts the AC voltage and causes the genset to run.

The genset runtime is adjusted on the DKG-190. When this timer is expired, the unit sends again the AC voltage to the genset controller causing the genset to stop. It also energizes its MC relay output. The genset stays in rest until batteries are discharged again.

When the mains is restored, the genset stops regardless of the battery charge status.

The unit measures and displays precisely battery, genset and mains voltages.

The AC voltage generated by the unit is a pure sinus with adjustable voltage and frequency. These features are obtained thanks to the high voltage PWM control and PID loop.

The unit can be virtually adapted to any genset controller thanks to its adjustable parameters.

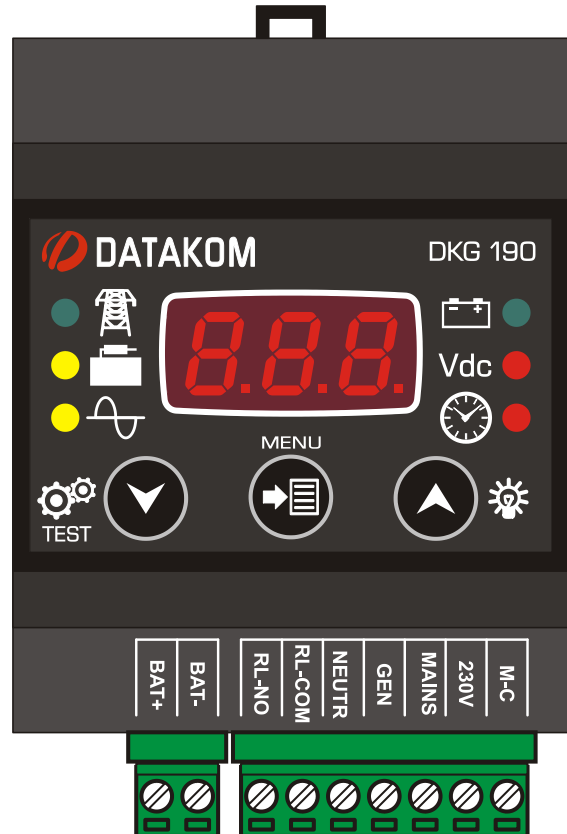

FEATURES

- **Supports both 24V and 48V DC systems**
- **Supply voltage range: 19-70VDC**
- **Accurate DC voltage measurement**
- **True RMS mains/genset voltage measurements**
- **Adjustable and PID controlled AC output**
- **Adjustable AC output frequency**
- **Pure sinus AC output voltage**
- **Mains contactor output**
- **Genset test capability**
- **Adjustable parameters**
- **DIN rail mounted**
- **Small dimensions**
- **Wide operating temperature range**
- **2 part connection system**



SAFETY WARNINGS



SAFETY NOTICE

Failure to follow below instructions will result in death or serious injury

- Electrical equipment should be installed only by qualified specialist. No responsibility is assured by the manufacturer or any of its subsidiaries for any consequences resulting from the non-compliance to these instructions.
- Check the unit for cracks and damages due to transportation. Do not install damaged equipment.
- Do not open the unit. There is no serviceable parts inside.
- Fuses must be connected to the supply input, in close proximity of the unit.
- Fuses must be of fast type (FF) with a maximum rating of 6A.
- Disconnect all power before working on equipment.
- When the unit is connected to the network do not touch terminals.
- Any electrical parameter applied to the device must be in the range specified in the user manual.
- Do not try to clean the device with solvent or the like. Only clean with a dry cloth.
- Verify correct terminal connections before applying power.

INSTALLATION

Before installation:

- Read the user manual carefully, determine the correct connection diagram.
- Install the unit to the DIN rail.
- Make electrical connections with plugs removed from sockets, then place plugs to their sockets.

Below conditions may damage the device:

- Incorrect connections.
- Incorrect power supply voltage.
- Voltage at measuring terminals beyond specified range.
- Current at measuring terminals beyond specified range.
- Overload or short circuit at the AC output
- Overload or short circuit at relay outputs

Below conditions may cause abnormal operation:

- Power supply voltage below minimum acceptable level.

ELECTRICAL INSTALLATION



Do not install the unit close to high electromagnetic noise emitting devices like contactors, high current busbars, switchmode power supplies and the like.

Although the unit is protected against electromagnetic disturbance, excessive disturbance can affect the operation, measurement precision and data communication quality.

- **ALWAYS** remove plug connectors when inserting wires with a screwdriver.
- **Fuses must be connected to supply inputs, in close proximity of the unit.**
- **Fuses must be of fast type (FF) with a maximum rating of 6A.**
- **Use cables of appropriate temperature range.**
- **Use adequate cable section, at least 0.75mm² (AWG18).**



Be sure that the AC output is not overloaded.

TECHNICAL SPECIFICATIONS

DC Supply Range: 19.0 - 70.0 V-DC.

Power Consumption: < 4W

Alternator Voltage: 0 - 300 V-AC (L-N)

Alternator Frequency: 45-65 Hz.

Mains Voltage: 0 - 300 V-AC (L-N)

Mains Frequency: 45-65 Hz

AC Voltage Accuracy: ±2V

DC Voltage Accuracy: ±0.2V

AC Output:

Voltage Range: 70-260VAC

Output Power: 0.5VA max

Min. Load Impedance: 100 k-ohms

Frequency Range: 45-65Hz

Regulation: PID

MC Relay Output: 5A @ 250V AC

Operating Temp Range: -20°C to 70°C

Storage Temp Range: -40°C to 80°C

Max. Relative Humidity: 95% non-condensing

IP Protection: IP30

Dimensions: 133 x 107 x 46mm (WxHxD)

Weight: 350 g (approx.)

Case Material: High temperature, flame retardant ABS/PC (UL94-V0)

Installation: DIN Rail mounted

EU Directives:

2006/95/EC (LVD)

2004/108/EC (EMC)

Reference Standards:

EN 61010 (safety)

EN 61326 (EMC)

INSTALLATION DIAGRAM

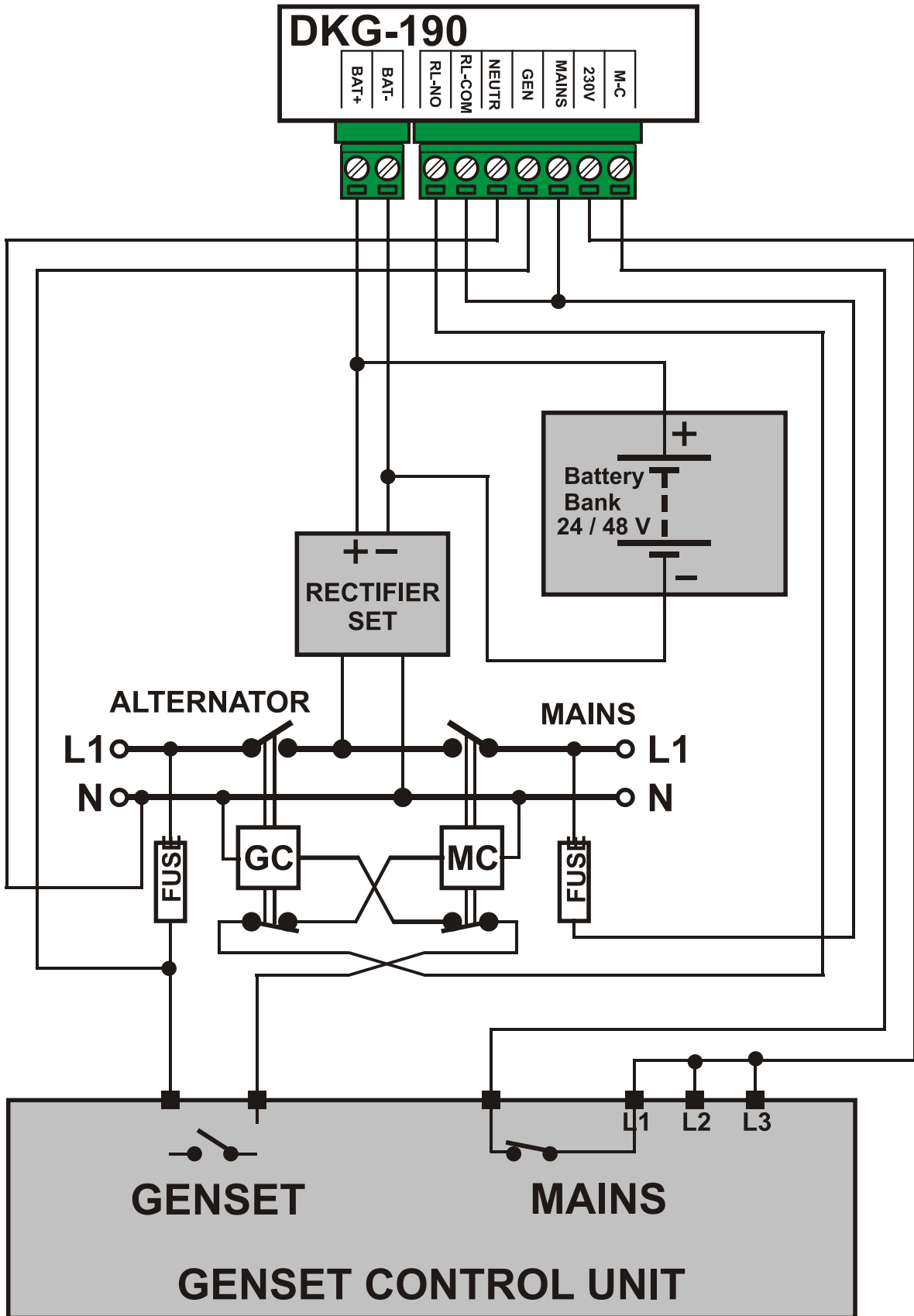

DISPLAYS AND PUSHBUTTON FUNCTIONS

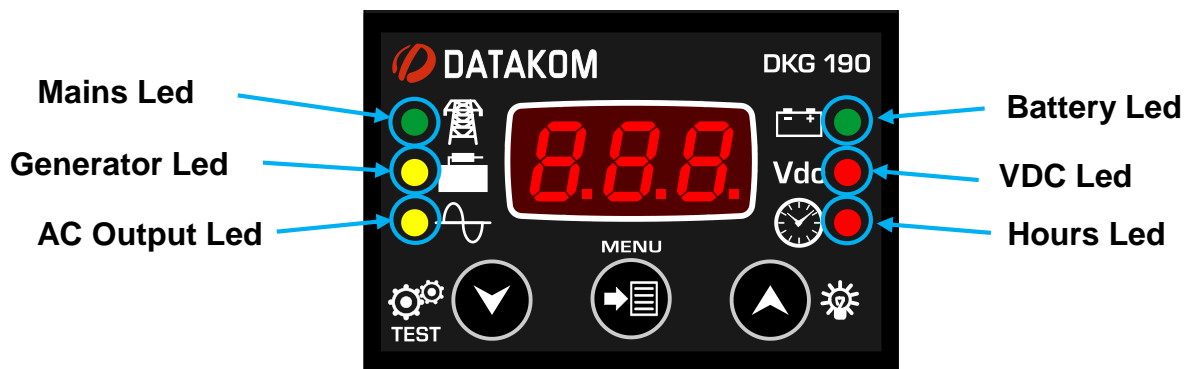

MAINS LED: Turns on when the mains is available. Turns off when the mains fails. When the mains is restored, flashes during the adjusted mains waiting timer (0-30 minute).







GENERATOR LED: Turns off when the genset is stopped. Turns on when the genset voltage is within limits.

AC OUTPUT LED: Turns on if the internal AC voltage is produced.

BATTERY LED: Turns on if the battery voltage is normal. Flashes if the genset is running and the voltage is normal. Turns off if the battery voltage is low.

VDC LED: Turns on when the battery voltage is displayed.











HOURS LED: Turns on when the screen displays the running timer.

BUTTON	FUNCTION
	Switches the screen to the next parameter.
	<u>HELD PRESSED DURING 3 SECONDS:</u> The genset goes to the TEST mode. The engine will run during the adjusted test timer and then stops. If any button is pressed during the test the genset stops immediately.
	<u>Programming mode:</u> increases the value.
	<u>Programming mode:</u> decreases the value.
	<u>HELD PRESSED DURING 3 SECONDS:</u> Goes to lamp test mode for 3 seconds.
	<u>HELD PRESSED TOGETHER DURING 3 SECONDS:</u> Goes to program mode. Or exits program mode.

PROGRAMMING

ENTERING THE PROGRAM MODE, ADJUSTING PARAMETERS

For the flexibility of use, the device offers a set of programmable parameters. Parameters are kept in a non-volatile memory and not affected by energy failures.

BUTTON	OPERATION	SCREEN
	In order to enter program mode, please hold pressed both arrow buttons for 3 seconds. The screen will display PGM.	
	Each depression of the Menu button will cause the unit to switch to the next parameter. The screen displays the name of the parameter.	
	If the Menu button is held pressed for 3 seconds , the value of the parameter to change is brought to screen.	
	Adjust the parameter by using the arrow buttons. In order to increase/decrease faster please hold the button pressed.	
	Pressing the Menu button will cause the parameter value to be written to memory and the display to switch to the next parameter.	

BUTTON	OPERATION	SCREEN
	In order to exit program mode please hold both arrow buttons pressed during 3 seconds.	







If no key is pressed during 1 minute the device will automatically close the program mode.





LAMP TEST



If the arrow-up button is held pressed for 3 seconds the Lamp Test mode will start.
In this mode all lights will turn on. After 3 seconds or if the Menu button is pressed the device resumes normal operation.

PROGRAM PARAMETER LIST

SCREEN	DESCRIPTION	MIN	MAX
	CHARGE TIMER (CHT) This parameter adjusts the charge time for the battery set. The format is Hours:Minutes.	0	18hour
	LOW BATTERY VOLTAGE LIMIT (bAt) This is the battery voltage where the genset starts.	9V	48V
	MAINS WAITING TIMER (iAt) This is the period between the mains is restored and the genset stops. The format is Minute:Second	0	30min
	MAINS VOLTAGE LOW LIMIT (iAL) Below this limit, the mains phase voltage is supposed to fail.	70V	270V
	MAINS VOLTAGE HIGH LIMIT (iAH) Above this limit, the mains voltage is supposed to fail.	100V	300V

SCREEN	DESCRIPTION	MIN	MAX
	GENSET VOLTAGE LOW LIMIT (9EL) Below this limit, the genset phase voltage is supposed to fail.	70V	270V
	GENSET VOLTAGE HIGH LIMIT (9EH) Above this limit, the genset voltage is supposed to fail.	100V	300V
	TEST TIMER (t5t) This is the period of test run. The format is Minute:Second	1	30min
	AC OUTPUT VOLTAGE (r15) The AC voltage produced by the controller is defined by this parameter. The usual value is 230V	40V	270V
	AC OUTPUT FREQUENCY (FrE) The frequency of the AC voltage produced by the controller is defined by this parameter. The usual value is 50 or 60 Hz	50Hz	60Hz